

15W, WIDE INPUT, DIP PACKAGE, ISOLATED & REGULATED SINGLE OUTPUT DC-DC CONVERTER



FEATURES

- ◆ Wide (4:1) Input Range
- ◆ Short Circuit Protection (automatic recovery)
- ◆ 1500VDC Isolation
- ◆ Operating Temperature: -40°C ~ +85°C
- ◆ Six sided metal shielding
- ◆ Over Voltage protection
- ◆ Internal SMD construction
- ◆ RoHS Compliance
- ◆ Industry Standard Pin Out
- ◆ MTBF > 1000K hours

MODEL SELECTION

15^①B^②24^③15^④Z^⑤PD^⑥

- ① Rated Power
- ② Product Series
- ③ Input Voltage
- ④ Output Voltage
- ⑤ Wide (4:1) Input Range
- ⑥ DIP Package Style

APPLICATIONS

The **15B-ZPD** Series are specially designed for applications where a wide range input voltage power supplies are isolated from the input power supply in a distributed power supply system on a circuit board.

These products apply to:

- 1) Where the voltage of the input power supply is wide range (Voltage range ≤ 4:1);
- 2) Where isolation is necessary between input and output (Isolation voltage ≤ 1500VDC);
- 3) Where the regulation of the Output voltage and the output ripple noise are demanded.



CE REACH
MICRODC RESERVES THE COPYRIGHT

SELECTION GUIDE

Order code	Input		Output		Efficiency (% Typ.)	Capacitance (max, uF.)
	Voltage (VDC)		Voltage (VDC)	Current (% Typ.)		
	Nominal	Range				
15B1203ZPD	12	9-18	3.3	3000	85	19000
15B1205ZPD	12	9-18	5	3000	88	10300
15B1212ZPD	12	9-18	12	1250	83	3340
15B1215ZPD	12	9-18	15	1000	82	1100
15B1224ZPD	12	9-18	24	675	81	900
15B2403ZPD	24	18-36	3.3	3000	81	19500
15B2405ZPD	24	18-36	5	3000	88	10200
15B2412ZPD	24	18-36	12	1250	81	3300
15B2415ZPD	24	18-36	15	1000	83	1100
15B2424ZPD	24	18-36	24	675	85	900
15B4803ZPD	48	36-75	3.3	3000	83	19500
15B4805ZPD	48	36-75	5	3000	81	10200
15B4812ZPD	48	36-75	12	1250	81	3300
15B4815ZPD	48	36-75	15	1000	84	1100
15B4824ZPD	48	36-75	24	675	81	900

COMMON SPECIFICATIONS

Parameter	Conditions	Min.	Typ.	Max.	Units
Storage humidity		5		95	%
Operating temperature		-40		85	°C
Storage temperature		-55		105	°C
Lead temperature	1.5mm from case for 10 seconds			300	°C
Case material	Steel, nickel coated, copper				
Isolation voltage	Tested for 1 minute and 1mA max		1500		VDC
Isolation resistance			1000		MΩ
Isolation Capacitance	100KHz/1V		1000		pF
MTBF			1000		K hours
Weight			45		g

INPUT SPECIFICATIONS

Parameter	Conditions	Min.	Typ.	Max.	Units
Start voltage/Under voltage shutdown	12V input models	8.6/8.1	8.8/8.	9/8.5	VDC
	24V input models	17.5/16	17.8/1	18/17	VDC
	48V input models	34/32	35/33	36/34	VDC
Start up time			20		MS
Input filter			Pi		
Method of Remote (Reference point: GND)	On	3.5-40VDC or open circuit			
	Off	0-1.2VDC			

TEMPERATURE CHARACTERISTICS					
Parameter	Conditions	Min.	Typ.	Max.	Units
Output voltage accuracy	Refer to recommended circuit		±1	±3	%
Over load protection	Input voltage range	120	130	150	%
Output Short Circuit	Input voltage range	Hiccup, automatic recovery			
Load regulation	From 10% to 100% load		±0.5	±1	%
Trim		±10%V0			VDC
Temperature drift (Vout)		0.02			%/°C
Line regulation	Input voltage from low to high		±0.2	±0.5	%
Ripple & Noise	Tested under 20MHz band	50	75	150	mV
Transient recovery time	25% load change		200	300	us
Transient peak deviation		±2	±3	±5	%
Over voltage protection	3.3V	3.63		4.29	VDC
	5V	5.5		6.5	VDC
	12V	13.2		15.6	VDC
	15V	16.5		19.5	VDC
	24V	26.4		31.2	VDC

Note:
 1. All specifications are measured at TA=25°C, humidity<75%, nominal input voltage and rated output load unless otherwise specified.
 2. The CTRL control pin voltage is referenced to GND.
 3. Typical efficiency value at nominal input voltage and full load.
 4. Capacitor MAX load tested at nominal input voltage and constant resistive load.
 5. Refer to the diagram of Output Voltage trim up/down for trim applications.
 6. The products cannot be used in parallel and in plug and play.

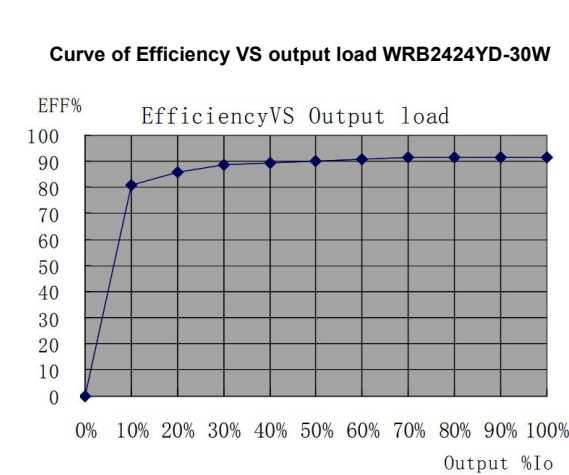
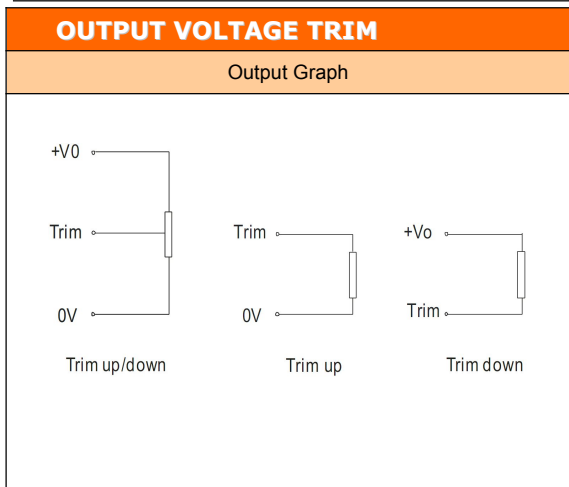
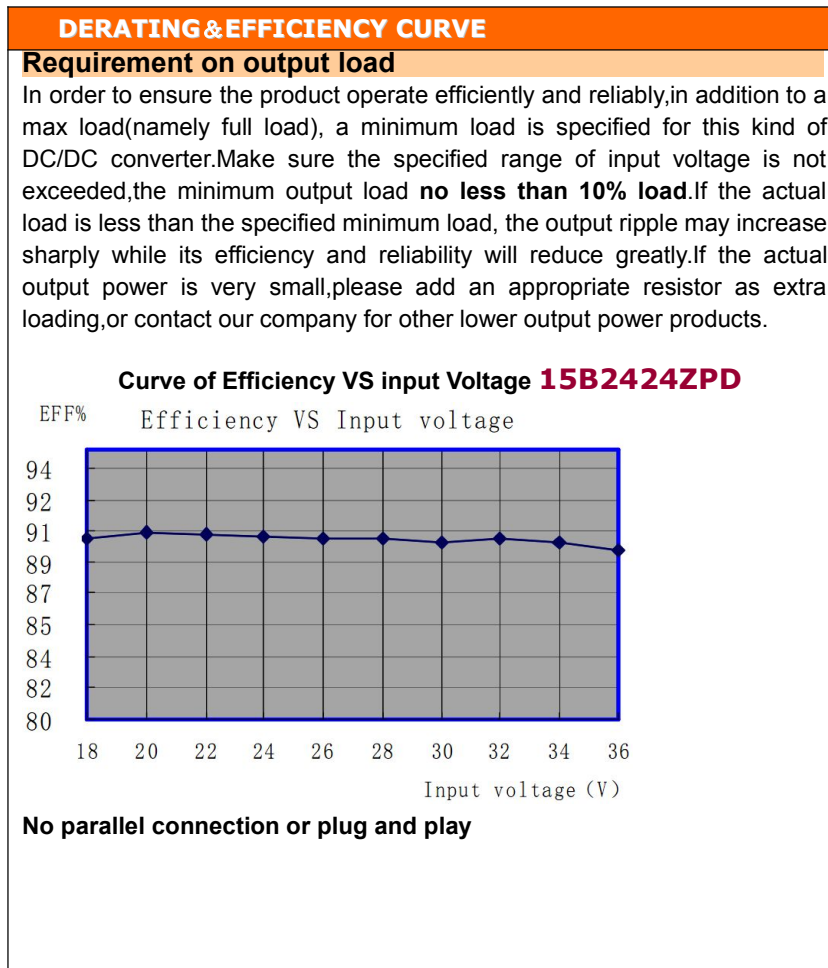
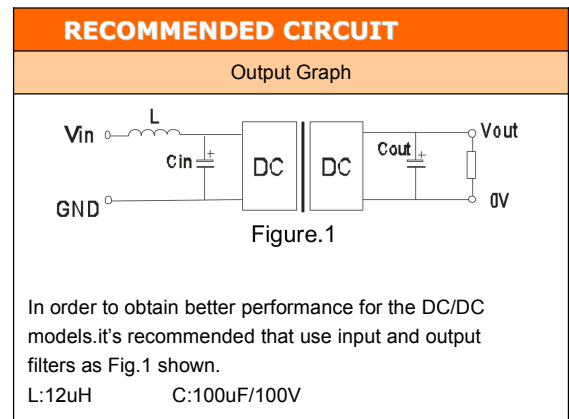
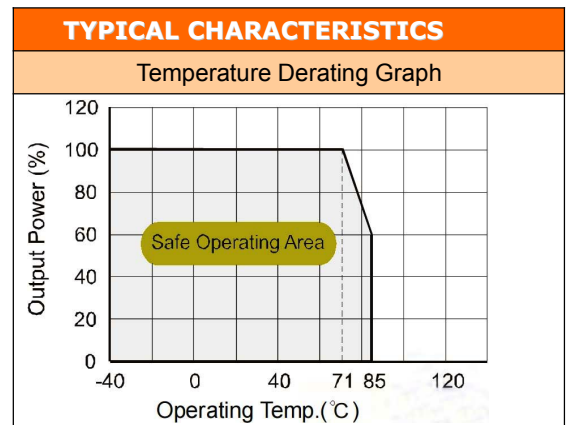

OUTLINE DIMENSIONS & FOOTPRINT DETAILS

MECHANICAL DIMENSIONS

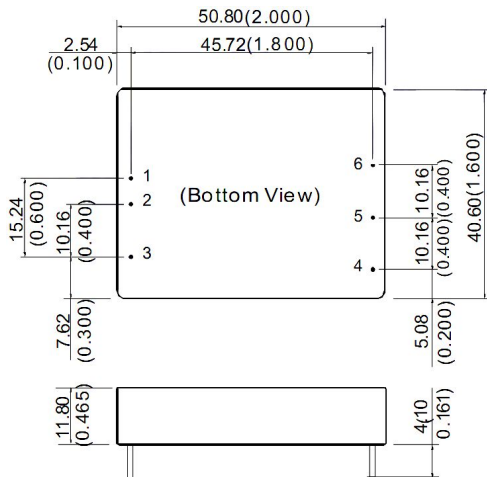

Note:
Unit:mm[inch]
Pin diameter:1.00mm[0.039inch]
Pin diameter tolerances:±0.05mm[±0.002inch]
General tolerances:±0.25mm[±0.010inch]

RECOMMENDED FOOTPRINT

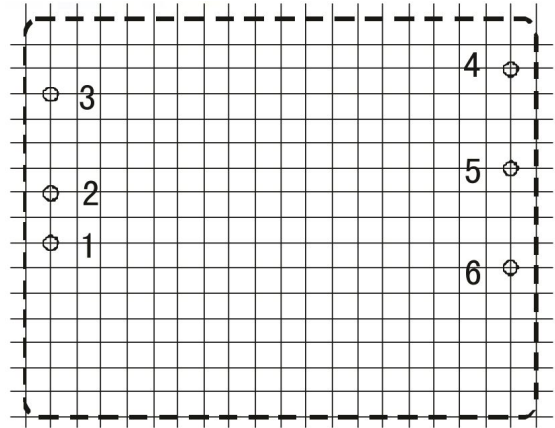

RECOMMENDED FOOTPRINT
Top view grid:2.54mm(0.1inch)
diameter:1.50mm(0.059inch)

FOOTPRINT DETAILS

Pin	Single	
1	Vin	
2	GND	
3	Ctrl	
4	Trim	
5	0V	
6	+Vo	

Note: The CTRL control pin voltage is referenced to GND
When the environment temperature is higher than 71°C, the product output power should be less than 60% of the rated power.
No parallel connection or plug and play.
Use dual output simultaneously,forbid pening output pin (0V) to use as single output.

TUBE OUTLINE DIMENSIONS

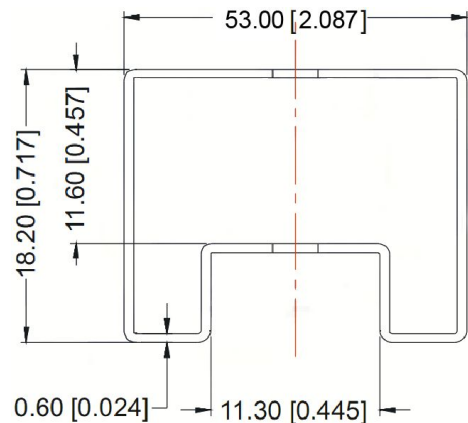

Note:
Unit :mm[inch]
General tolerances:±0.250mm[±0.010inch]

- Note:
1. The CTRL control pin voltage is referenced to GND.
 2. Typical efficiency value at nominal input voltage and full load.
 3. All specifications measured at Ta=25°C, humidity<75%, nominal input voltage and rated output load unless otherwise specified.
 4. In this data sheet, all the test methods of indications are based on corporate standards.
 5. Capacitor MAX load tested at nominal input voltage and constant resistive load.